

11

IMPACT TILT LATCH 800 SURFACE LATCH



Metal Surface Latch
Strength Design Throughout

- Metal Base and Bolt
- Interlocking housing and bolt
- Extended reach bolt
- Hole spacing to reach reinforcement

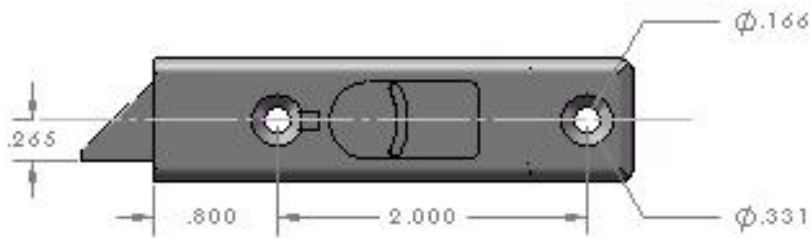

PART NUMBER	COLOR CODE
L-M800HBT-xx	XX
L-M800HBL-xx	XX

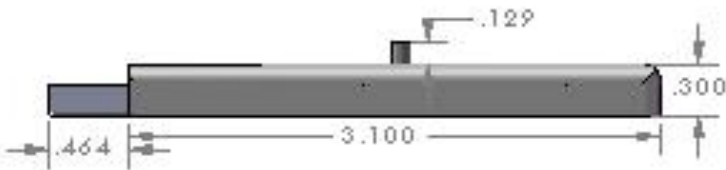

12

IMPACT JAMB CLIP JAMB REINFORCEMENT CLIPS

Provides strength to the tilt latch and jamb return leg.

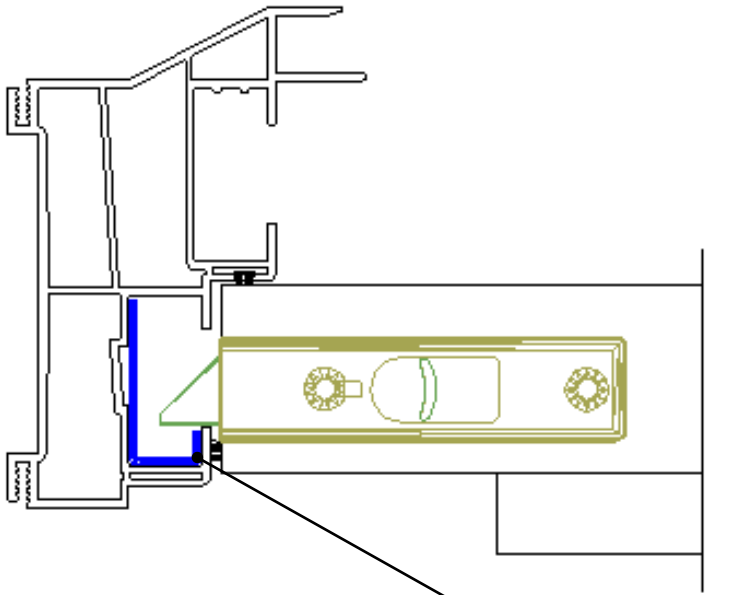

Jamb Reinforcement Clip

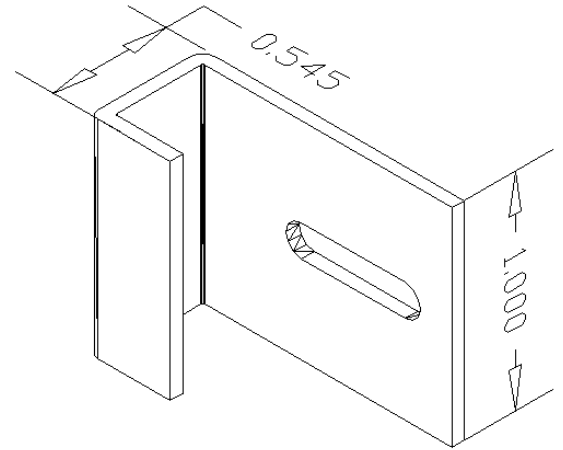

PART NUMBER

CBP970

CB9705

CB9755

CB960

CB962

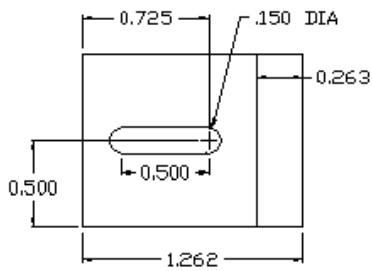

Part # CB970S

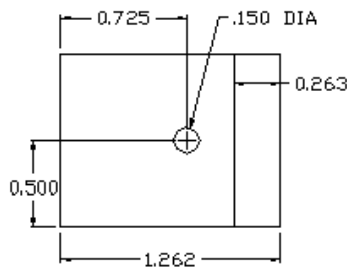

Part # CB970

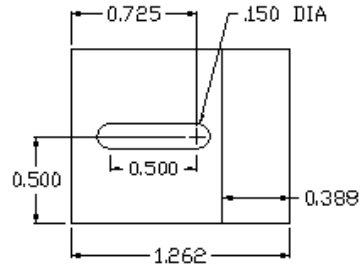

Part # CB975S

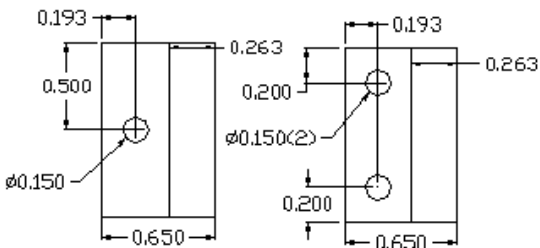

Part # CB960

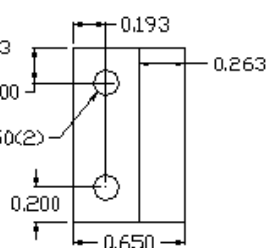

Part # CB962

